

## DATA SHEET – DIMENSIONS

**10449: MINI HYDRAULIC POWER-PACK UNIT 230V AC (1.5 KW) - 5.8 CC - 8.2 LIT/MIN - TANK 6 LIT**

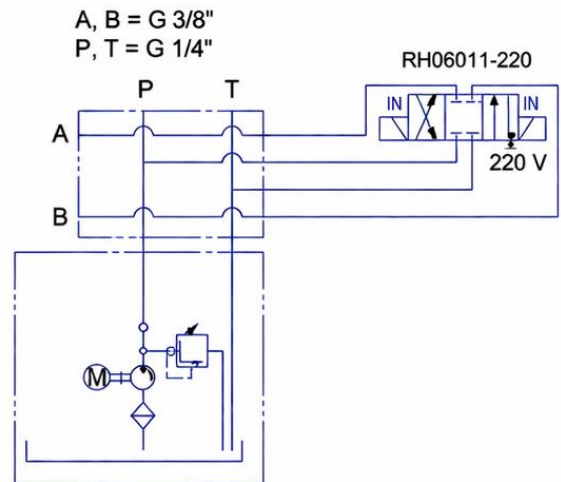

## 10448: MINI HYDRAULIC POWER-PACK UNIT 380V AC (1.5 KW) - 5.8 CC - 8.2 LIT/MIN - TANK 6 LIT

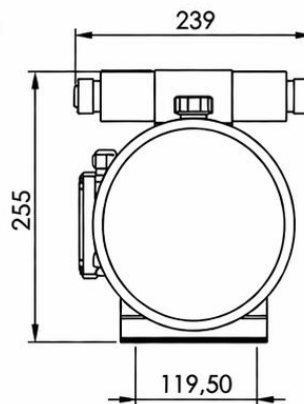
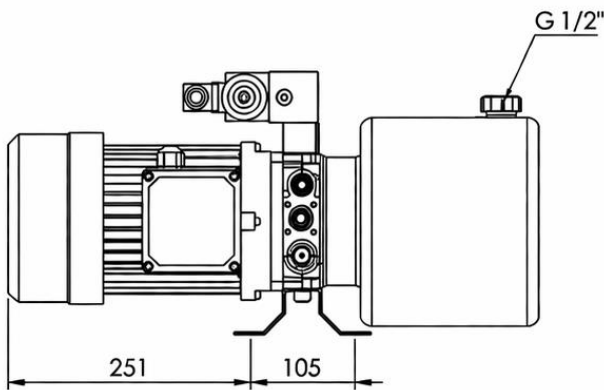
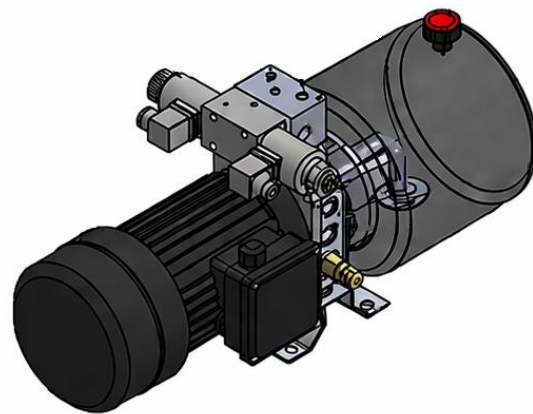
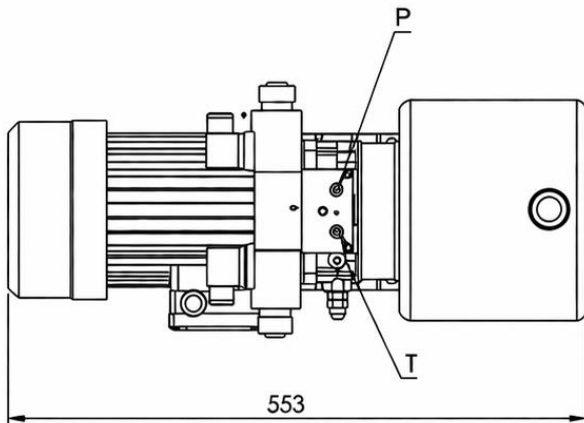
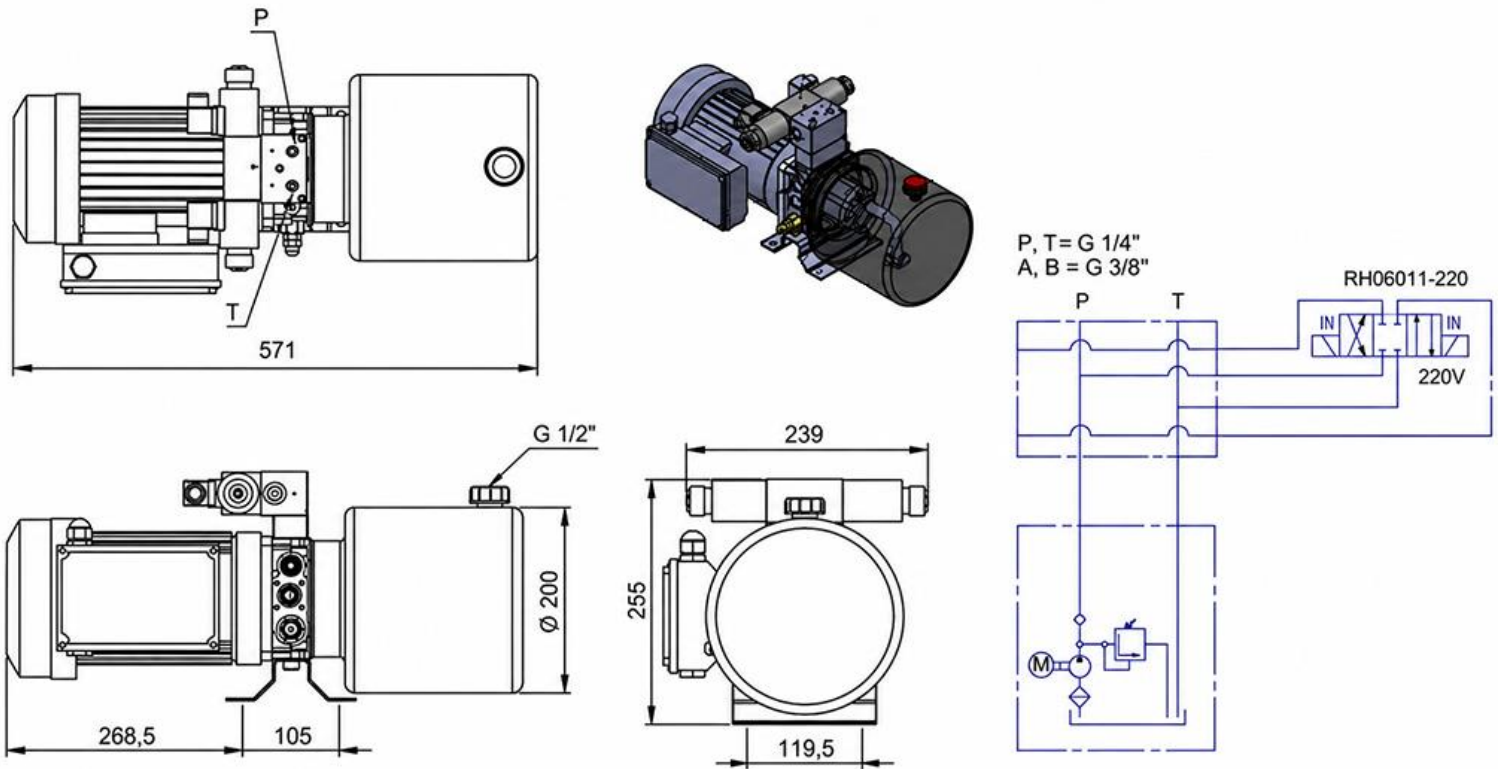

CODE	VOLTAGE (V)	MOTOR POWER (kW)	MAX. PRESSURE (bar)	PUMP FLOW (cc)	OIL TANK CAPACITY (l)	FLOW OF POWER PACK (lit/min)	SPEED (vrt/min)
10449	230	1,5	90	5,8	6	8,2	1500
10448	380						

CIRCUIT DIAGRAM:

